

1953-54 CHEVY CARS

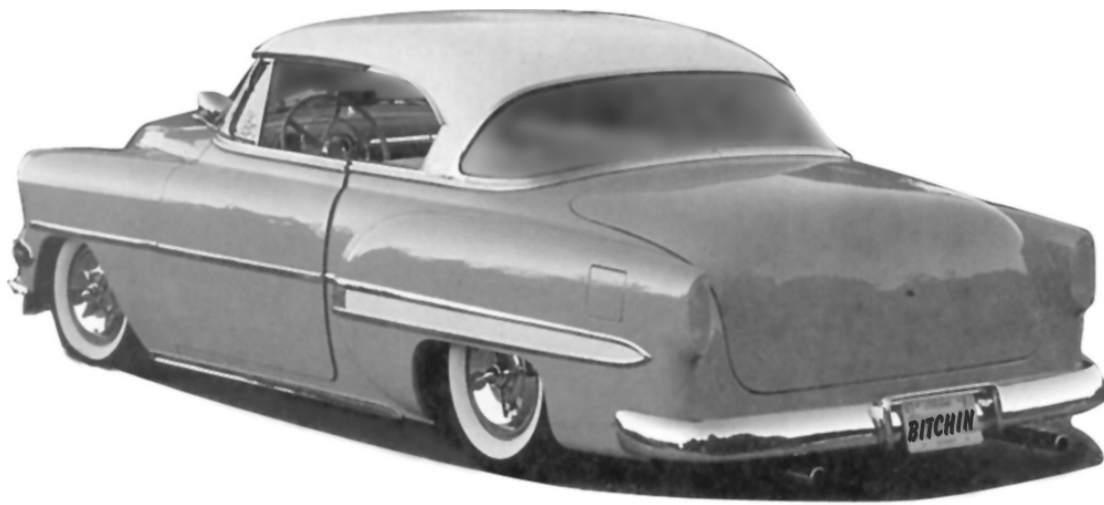

Bitchin Parts For Bitchin Cars

FIREWALL & TECHNICAL INFO	2
FLOORBOARD KITS.....	2
APRON KITS.....	2
UNIVERSAL PARTS.....	3
COWL VENT FILLERS.....	4

All Prices are subject to change without notice.

FIREWALLS & TECHNICAL INFO



\$456.00

753100 53-54 FIREWALL KIT

This kit will handle small or big block engines easily.

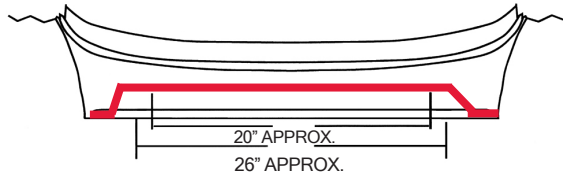

753100 53-54 CHEVY FIREWALL
(4 1/2" SET-BACK) 26" Wide

These references are to help you decide which firewall kit will best fit your particular application. There are many factors which will affect your choice of kits; engine set-back, radiator core thickness, air conditioning or super chargers. You need to determine the length of the engine package you intend to install & then figure out the distance you have from the back of the radiator core to the stock or existing firewall. To do this you will know how much extra room or set-back you will need. The firewall only fits in one place in the body, but your engine can be moved forward or backward as much as needed to obtain proper clearances. If you have any questions, please call our customer service dept. @ (928) 420-6346.



FLOORBOARD KITS



\$358.00

753105 53-54 FLOORBOARD KIT

Matches up to 753100 Firewall Kit.
 (Goes back to the front edge of the stock seat riser for those using Stock seats).



\$599.00

753110 53-54 FLOORBOARD KIT

(Goes from 753100 Firewall back to the front of the rear seat riser). This flat floor is used with a variety of different seats.



APRON KITS



\$418.00

753120 53-54 APRON KIT

Smooth not shown.



\$495.00

753115 53-54 APRON KIT

Louvered

The 1953-54 fender aprons are ugly, also they are either rusted or drilled full of holes. If you're like most Street Rodders, you want your engine to look really trick. Bitchin Parts manufactures a really "Bitchin" set of front fender aprons. It can be purchased either smooth or Louvered. Each kit is made of 18 gauge steel & comes with instructions, new stone guards & mounting brackets.

UNIVERSAL FLOORS

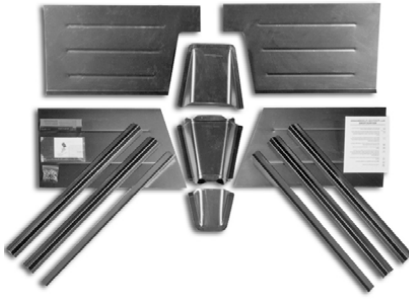

901030 \$325 All Purpose Front Floor Kit



901035 \$325 All Purpose Rear Floor Kit

BATTERY BOXES

BATTERY BOXES

Group 42	901020	\$110.00
Group 71	901006	\$110.00
Optima Box	901040	\$110.00

Mounting a battery in a street rod has always created problems, some major and some minor. Our battery box kits will solve most of the problems. The universal mounting brackets supplied with these kits allow you to choose the mounting method which best suits your application, including flush floor mounting, side mounting, or halfway through the floor for extra ground clearance. We offer three kits. The positive battery hold down, adequate ventilation & cable protection give added security to your battery installation.

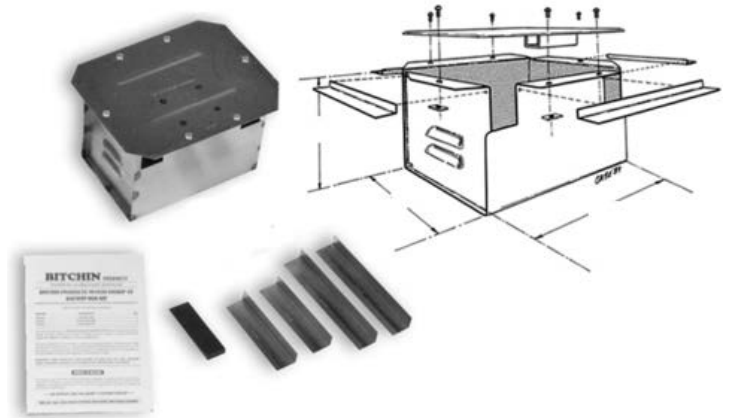

Group 42: 9 3/4 L x 7 W x 7 1/2 H
 Group 71: 8 1/2 L x 7 1/4 W x 9 1/4 H
 Optima: 10 1/2 L x 7 1/4 W x 8 1/2 H

UNIVERSAL DEEP WHEEL TUB



901010 \$358 Deep Wheel Tubs Universal

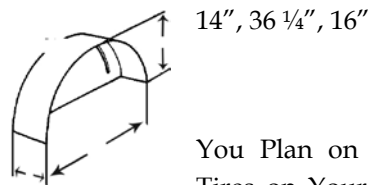

You Plan on Putting Wide Wheels & Tires on Your Car or Pro-Streeting it, We Have Just What You Need. Our Universal Deep Wheel Tub Kit (No. 901010) Was Designed for Just That. These 18 Gauge Cold Rolled All Steel Wheel Tubs Are 36" From End to End & a Full 14" Deep. You Can Install These Beauties In As Deep As You Like for Your Particular Project. All Our Deep Wheel Tub Kits Have Mounting Angles.

COWL VENT FILLERS

CARS

CAR YEAR / TYPE	PART #	PRICE
32' Ford Car	321097	\$24.00
33'-34' Ford Car	331084	\$24.00
35'-36' Ford Car	351082	\$24.00
37'-40' Ford Car	371037	\$24.00
41'-48' Ford & Mercury Car	421083	\$24.00
37'-39' Chevy Car	737200	\$24.00
40' Chevy Car	740111	\$24.00

TRUCKS

TRUCK YEAR / TYPE	PART #	PRICE
32'-34' Ford Truck	321097	\$24.00
35'-36' Ford Truck	331084	\$24.00
37'-47' Ford Truck	371037	\$24.00
48'-52' Ford Truck	481037	\$24.00
47'-53' Chevy Truck (Top)	751023	\$24.00
47'-50' Chevy Truck (Side)	751024	\$24.00
54'-55' Chevy Truck (Top)	751060	\$24.00

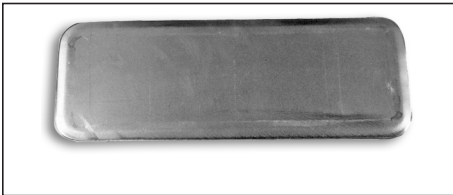

321097 32' Ford Car

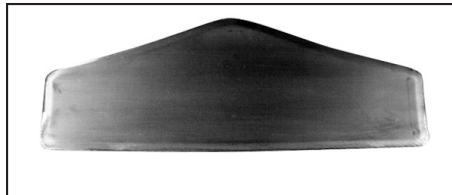

331084 33'-34' Ford Car & 35'-36' Ford Truck

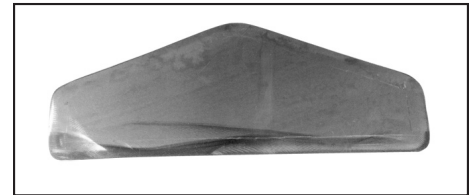

351082 35'-36' Ford Car

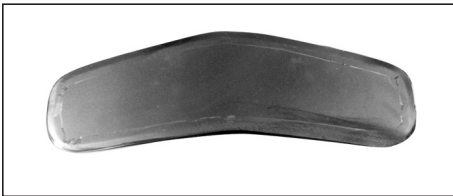

371037 37'-40' Ford Car & 37'-47' Ford Truck

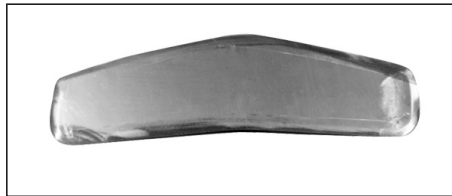

421083 41'-48' Ford & Mercury Car



481037 48'-52' Ford Truck

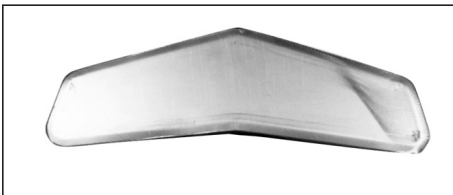

737200 37'-39' Chevy Car

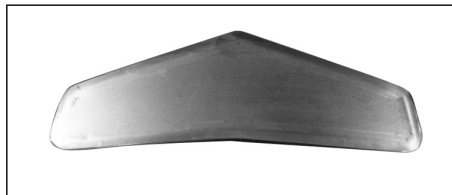

740111 40' Chevy Car

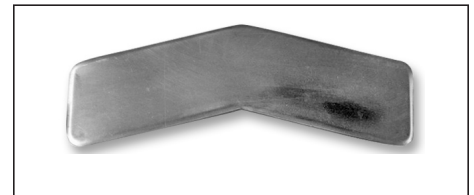

751023 47'-53' Chevy Truck (Top)



751024 47'-50' Chevy Truck (Side)

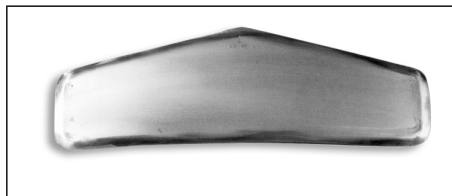

751060 54'-55' Chevy Truck (Top)



BITCHIN

Our Cowl Vent Fillers are made from 18 Gage cold rolled steel & are a little larger than the Stock Cowl so they can be trimmed for a perfect fit. The edges are beveled so the weld area is below surface making it easier for a flush fit. Swap meet the original, & pocket the difference.

Bitchin T-Shirts Now Available!

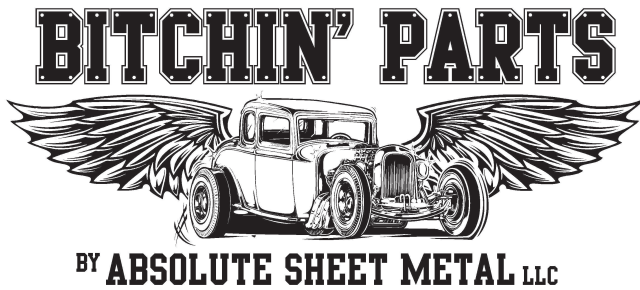

Jeff Hill, Owner, modeling our t-shirt while working in his shop.

ONLY \$15.95!

**Sizes: Medium to 3XL
Black or White T-Shirt**